

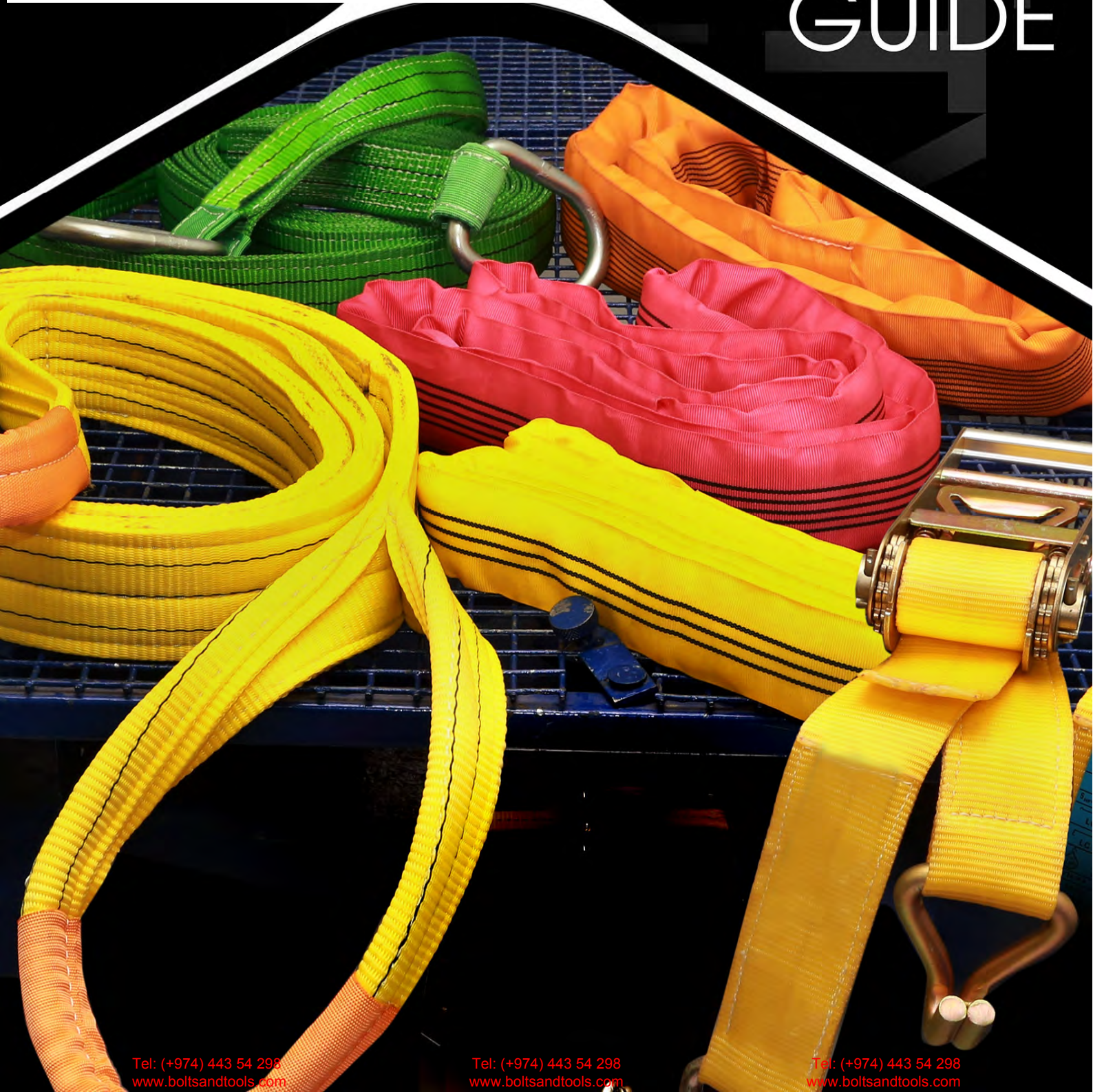

THE LIFTING & LASHING SOLUTIONS GUIDE

مركز البراغي والعدد
BTGO
BOLTS & TOOLS CENTER



	PAGE
ALLSAFE INTRODUCTION	1
WHY ALLSAFE?	2
FLAT WEBBING SLINGS	4
EYE TYPES / PROTECTION POLYESTER SLEEVE	6
SLINGS WITH METAL FITTINGS	7
TUBULAR ROUND SLINGS	8
ROUND SLINGS	9
MULTI-LEG SLINGS	10
TOW STRAP	11
SPECIAL SLINGS	12
CARGO LASHINGS	14
INSPECTION CRITERIA FOR WEBBING SLINGS	16
RECOMMENDATIONS FOR USE, HOW TO ORDER	17
OUR CERTIFICATIONS	19
OUR IDENTIFICATION	20



ALLSAFE was established in 1998 in the Middle East, where we started as a sole manufacturer of polyester slings, cargo lashings and fall arrest products. We rapidly grew on to become one of the leading manufacturers in the Middle East through our qualified and approved distributors.

Today, ALLSAFE manufactures and distributes a wide variety of polyester flat webbing slings, rounds slings, cargo lashings and special slings.

State of the art facilities for production and quality control have been set up to ensure the highest standards for all our products.

Through aggressive marketing, ALLSAFE has made a strong impact in the Middle East, Asia, Africa and Europe and we are now serving more than 25 countries worldwide.

In 2007, ALLSAFE had been taken over by the renowned Delta Plus Group, listed on the Paris Stock Exchange since 1999 and worldwide leader in the manufacture and distribution of Personal Protective Equipment.

PROVEN TRACK RECORD

During the last 15 years of service in the market, our success has been contributed mainly due to our consistency in quality and maintaining customer satisfaction.

ALLSAFE is an ISO 9001:2008 and 11B certified company. All our products are in accordance with European Norms.



WHY ALLSAFE?



SYSTEMATIC MANUFACTURING PROCESS

The core of our activity is the manufacturing of lifting and lashing products for various industries like Construction, Oil & Gas, Transport, Marine Industries and many more. Latest technology and machinery are adapted to manufacture all our products. Automatic cutting and fabricating machines are used to have uniformity and consistency.



STRINGENT TESTING FACILITY

In house and external testings are carried out on all our raw material and products. Heavy duty tensile testing machine with a capacity of 90 ton enables all kind of test for all webbing used. Regular in-process inspection and testing using measuring equipment calibrated to International standards maintains the top quality of our products. Static and dynamic testings of finished products ensure compliance with all the highest standards.



WHY ALLSAFE?



QUALITY MANAGEMENT SYSTEMS AND CERTIFICATION

ALLSAFE is an ISO 9001:2008 and 11B certified company. Starting from the test of the raw material and throughout the entire manufacturing process and till the finished products, all our products are following strict quality controls and inspection techniques.

We have determined the various processes needed for the quality management system.

The processes are monitored, measured and analyzed to the extend applicable.

The nature of our activity makes the QUALITY our top priority.



CERTIFICATION AND THIRD PARTY INSPECTION

All our products are provided with certificate of conformity or EC declaration of conformity as the case may be. The third party inspection of product can be arranged for all orders. Customers can appoint their own third party inspection agency to inspect and certify our products.

FLAT WEBBING SLINGS

FLAT WEBBING SLING

We manufacture flat webbing slings as per European Norm, EN1492-1 with a safety factor of 7:1. The color and the number of black lines on the webbing indicate the Safe Working Load (SWL) / Working Load Limit (WLL) of the sling.

Webbing slings are made from high tenacity 100% polyester (PES) webbing material manufactured according to EN standards. These slings have the following advantages:

- Low weight, therefore offering easy handling
- Protection against hand injuries
- Protection against cargo surface damage
- Highly flexible and adaptable to given shapes
- UV-resistant, eliminating material ageing or brittleness
- Heat resistant up to 100°C
- Water - resistant fabric, preventing frost damage (down to -40°C)
- Colour coded as per latest EN standard.
- Soft sewn eyes (Flat, Becket or Reverse eyes)
- Low elongation

Safety instructions

- SAFETY FACTOR The minimal value must be at least equal to:
7:1 for webbing and round slings
5:1 for accessories made of steel
- BREAKING STRENGTH
Webbing slings and round slings must resist to strength at least equal to 7 times their SWL.

Webbing sling ME type

Manufactured according to EN 1492-1 standards, the width of the webbing of these slings are designated in millimeters, starting with a minimum width of 30mm and going up to 300mm. For the same tonnage you get a wider webbing and hence a larger area for the load in this type of slings. These slings are constructed in a double layer type and have black lines on the face of the webbing. The number of black lines on the webbing indicates the safe working load of the sling

- High flexibility and ease of handling
- Wider webbing for the same tonnage
- Less abrasion due to wider area of contact
- Longer life due to less wear and tear





FLAT WEBBING SLINGS

Flat slings are manufactured to EN 1492-1 safety factor of 7:1

Flat polyester sling type ME
(Webbing width in mm)

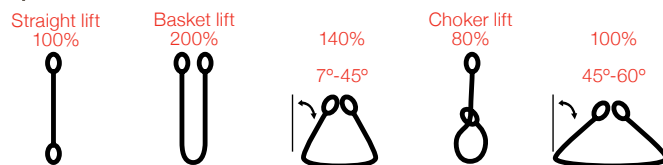

REF	COLOUR	SWL/WLL	WIDTH	SWL / WLL IN KG AT DIFFERENT MODES				
ME1	VIOLET	1T	30mm	1000	2000	1400	800	1000
ME2	GREEN	2T	60mm	2000	4000	2800	1600	2000
ME3	YELLOW	3T	90mm	3000	6000	4200	2400	3000
ME4	GREY	4T	120mm	4000	8000	5600	3200	4000
ME5	RED	5T	150mm	5000	10000	7000	4000	5000
ME6	BROWN	6T	180mm	6000	12000	8400	4800	6000
ME8	BLUE	8T	240mm	8000	16000	11200	6400	8000
ME10	ORANGE	10T	300mm	10000	20000	14000	8000	10000

Flat polyester sling type IE
(Webbing width in inch)

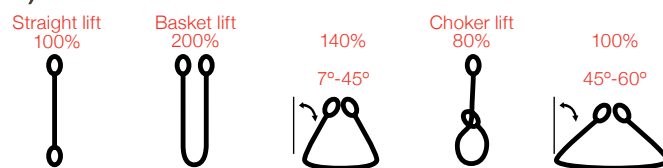

REF	COLOUR	SWL/WLL	WIDTH	SWL / WLL IN KG AT DIFFERENT MODES				
IE1	VIOLET	1T	1"/25 mm	1000	2000	1400	800	1000
IE2	GREEN	2T	2"/50 mm	2000	4000	2800	1600	2000
IE3	YELLOW	3T	3"/75 mm	3000	6000	4200	2400	3000
IE4	GREY	4T	4"/100 mm	4000	8000	5600	3200	4000
IE5	RED	5T	5"/125 mm	5000	10000	7000	4000	5000
IE6	BROWN	6T	6"/150 mm	6000	12000	8400	4800	6000
IE8	BLUE	8T	8"/200 mm	8000	16000	11200	6400	8000
IE10	ORANGE	10T	10"/250 mm	10000	20000	14000	8000	10000
IE12	ORANGE	12T	12"/300 mm	12000	24000	16800	9600	12000



EYE TYPES / PROTECTION

POLYESTER SLEEVE

EYE TYPES

FLAT EYE

Category 1 (Type 44)



FOLDED EYE

Category 2 (Type 45)



REVERSED EYE

Category 3 (Type 55)



EYE REINFORCEMENT

Soft Eyes can be reinforced with leather or polyester protection

Leather



Polyester

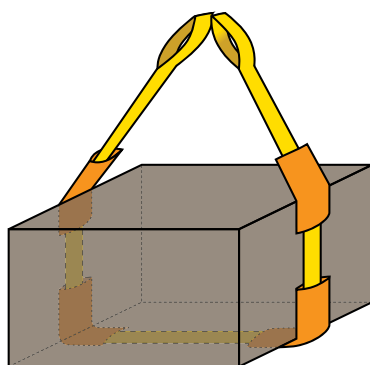

Polyester slings are susceptible to cuts and abrasions and should not be exposed to sharp edges.

Sleeves can be provided for all size of slings to protect the slings from sharp edges and abrasion. Using sleeves will enhance life of the sling.



Flat webbing slings of various other capacities (from 0.5T to 24T) can be manufactured with single, double, three or four ply construction.

Slings with a safety factor 6:1 are available on request



SLINGS WITH METAL FITTINGS

Slings with metal fittings are provided for more safety and durability

Male / Female Fittings
REEVING

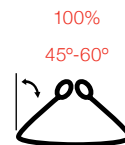
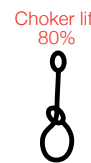
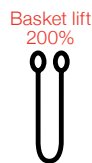
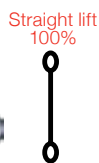

REF	COLOUR	SWL/WLL	WIDTH	SWL / WLL IN KG AT DIFFERENT MODES				
1TMF	VIOLET	1T	30 mm	1000	2000	1400	800	1000
2TMF	GREEN	2T	60 mm	2000	4000	2800	1600	2000
3TMF	YELLOW	3T	90 mm	3000	6000	4200	2400	3000
4TMF	GREY	4T	120 mm	4000	8000	5600	3200	4000
5TMF	RED	5T	150 mm	5000	10000	7000	4000	5000
6TMF	BROWN	6T	180 mm	8000	12000	8400	4800	6000
8TMF	BLUE	8T	240 mm	7000	16000	11200	6400	8000
10TMF	ORANGE	10T	300 mm	10000	20000	14000	8000	10000

Male / Male Fittings
NON-REEVING

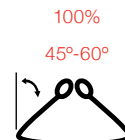

REF	COLOUR	SWL/WLL	WIDTH	SWL / WLL IN KG AT DIFFERENT MODES			
1TMM	VIOLET	1T	30 mm	1000	2000	1400	1000
2TMM	GREEN	2T	60 mm	2000	4000	2800	2000
3TMM	YELLOW	3T	90 mm	3000	6000	4200	3000
4TMM	GREY	4T	120 mm	4000	8000	5600	4000
5TMM	RED	5T	150 mm	5000	10000	7000	5000
6TMM	BROWN	6T	180 mm	6000	12000	8400	6000
8TMM	BLUE	8T	240 mm	8000	16000	11200	8000
10TMM	ORANGE	10T	300 mm	10000	20000	14000	10000

FLAT ENDLESS SLING

Two types of endless polyester slings made of flat woven webbing are manufactured by us:

SINGLE LAYER ENDLESS SLING



DOUBLE LAYER ENDLESS SLING



TUBULAR ROUND SLINGS

TUBULAR ROUND SLING (TRS)

Round slings are manufactured to EN1492-2 and have a safety factor of 7:1. The load bearing fibers are wound together to form an endless hank. The working load limit is determined by the number of turns in the hank.

Tubular Round Sling (TRS) are manufactured on a round sling machine. Slings made on this machine are more compact as the winding of the yarn is uniform and the tension on each yarn is constant.

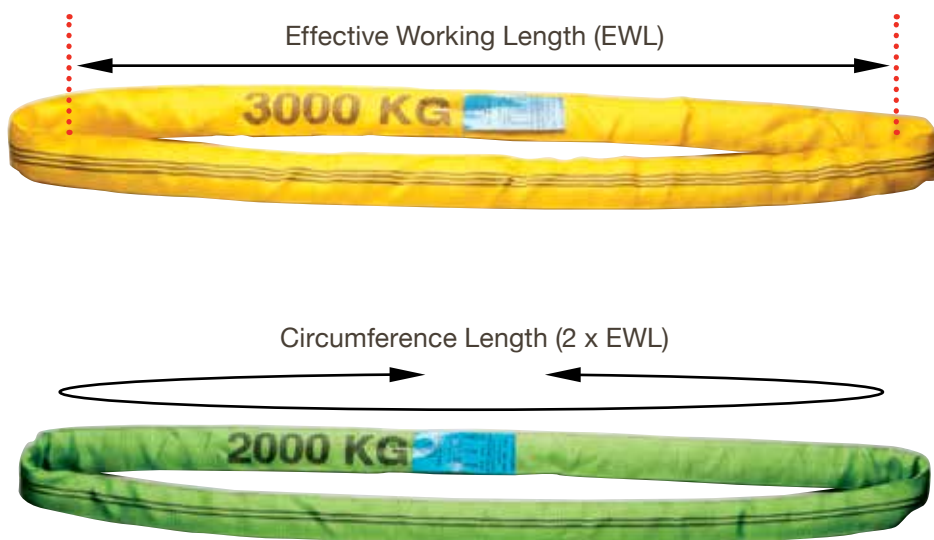

- Individual certificates provided with every Sling
- All slings can be provided with polyester protective sleeve of any length.
- Two types of sleeves :



Type 1

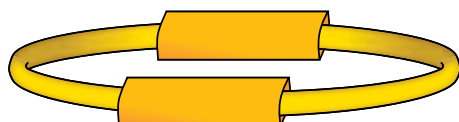

Type 2





ROUND SLINGS

Round slings are manufactured to EN 1492-2 safety factor of 7:1.

Round sling from 1T to 10T

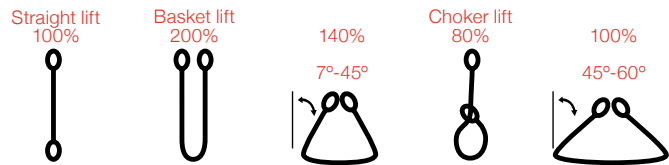

REF	COLOUR	SWL/WLL	WIDTH	SWL / WLL IN KG AT DIFFERENT MODES				
TRS1	VIOLET	1T	44mm	1000	2000	1400	800	1000
TRS2	GREEN	2T	46mm	2000	4000	2800	1600	2000
TRS3	YELLOW	3T	60mm	3000	6000	4200	2400	3000
TRS4	GREY	4T	67mm	4000	8000	5600	3200	4000
TRS5	RED	5T	78mm	5000	10000	7000	4000	5000
TRS6	BROWN	6T	83mm	6000	12000	8400	4800	6000
TRS8	BLUE	8T	95mm	8000	16000	11200	6400	8000
TRS10	ORANGE	10T	112mm	10000	20000	14000	8000	10000

Round sling from 10T to 100T

Heavy duty round slings above 10 tons are provided with a double cover and two protective sleeves. Sleeves can be specially ordered to any required length.

REF	COLOUR	SWL/WLL	W/m	WIDTH	SWL / WLL IN KG AT DIFFERENT MODES				
RS10	ORANGE	10T	2.2	50mm	10000	20000	14000	8000	10000
RS15	ORANGE	15T	3.5	55mm	15000	30000	21000	12000	15000
RS20	ORANGE	20T	4.8	60mm	20000	40000	28000	16000	20000
RS25	ORANGE	25T	6.1	65mm	25000	50000	35000	20000	25000
RS30	ORANGE	30T	6.9	70mm	30000	60000	42000	24000	30000
RS40	ORANGE	40T	9.5	85mm	40000	80000	56000	32000	40000
RS50	ORANGE	50T	11.6	100mm	50000	100000	70000	40000	50000
RS60	ORANGE	60T	13.6	110mm	60000	120000	84000	48000	60000
RS80	ORANGE	80T	16.9	125mm	80000	160000	112000	64000	80000
RS100	ORANGE	100T	23.2	135mm	100000	200000	140000	80000	100000

Centre-stitched Round Sling (RS)

The covers of round slings from 1 to 6 ton are provided with a centre stitch.



Side-stitched Round Sling (RS)

Round slings of all sizes can be made with a side stitched cover.

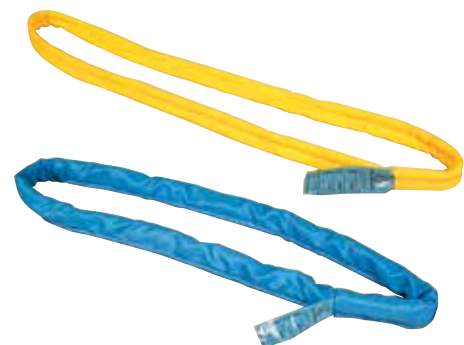

MULTI-LEG SLINGS

MULTI-LEG SLINGS

Multi-leg slings are manufactured with either flat webbing slings or with round slings in combination with high quality steel components like master link assemblies, bow shackles and different variety of eye hooks.

They are manufactured according to EN1492-1 if the textile part is a webbing sling or according to EN1492-2 if the textile part is a round sling. The textile part of the multi-leg sling has a safety factor of 7:1 and the metal part has a safety factor of 5:1.

Multi-leg slings can be manufactured in different assemblies having two legged, three legged or four legged slings. They can have different combination of hooks like, eye hook, self locking hook, hook with lashes, etc. at the lower end of the sling to suit different lifting applications.

Textile Multi-leg slings are easy to use and provide many advantages over other multi-leg slings:

- Easier to handle as compared to wire rope or chain
- The total weight of the assembly is less
- Master link creates sufficient space on the crane hook
- Round slings can be rotated to have different bearing points thus resulting in uniform wear
- Proper and even distribution of load

Safe working load

Two legged sling

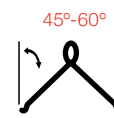

CAPACITY OF EACH SLING	COLOUR	SWL / WLL IN KG AT DIFFERENT MODES	
1000kg	VIOLET	1400	1000
2000kg	GREEN	2800	2000
3000kg	YELLOW	4200	3000
4000kg	GREY	5600	4000
5000kg	RED	7000	5000
6000kg	BROWN	8400	6000



Four legged sling

CAPACITY OF EACH SLING	COLOUR	SWL / WLL IN KG AT DIFFERENT MODES	
1000kg	VIOLET	2100	1500
2000kg	GREEN	4200	3000
3000kg	YELLOW	6300	4500
4000kg	GREY	8400	6000
5000kg	RED	10500	7500
6000kg	BROWN	12600	9000

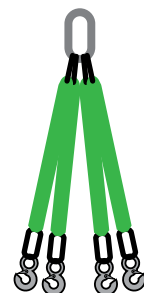



TOW STRAP

THE TOW STRAP IS USED TO TOW CAR

A tow strap is a strap with hooks on each end allowing the user to pull a vehicle. It is made from tough polyester material. If your car breaks down in an undesirable location, you can use tow strap to move your car to a safer place.

Safety Tips:

- Look for a solid point in the rear for mounting
- Both the vehicles have to be manned
- The vehicle doing the pulling should move forward very slowly until the tow strap is taut
- All movements should remain smooth and gradual (Accelerations and decelerations)

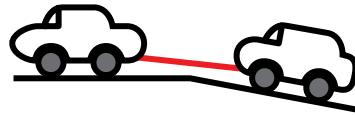

FEATURES

- High quality, heavy duty polyester tow-straps
- Strong and light weight hooks
- Can be used for towing and recovery applications
- Breaking strength: 9000 lbs
- Width of webbing: 50mm
- Standard length: 6m
- Vehicle weight permissible: 5000 lbs



SPECIAL SLINGS

PIPE LAYING SLING

Pipe Laying Slings, also known as lowering-in belts for pipelines are manufactured according to industry standard and according to specific requirements of the customer.

These slings are used for easy laying of pipes for oil and gas industry. PLS consists of three parts – the alloy steel rams horn head fitting, the end plates and the webbing. The slings are manufactured using heavy duty polyester webbing for durability and strength.

PIPE DIAMETER	CAPACITY	WIDTH	LENGTH	Nb OF HORNS	WT/SET(kg)
24"	30T	24"	2.5m	3	115
30"	40T	30"	3.0m	4	145
36"	50T	36"	4.0m	4	200
48"	50T	48"	5.0m	5	240

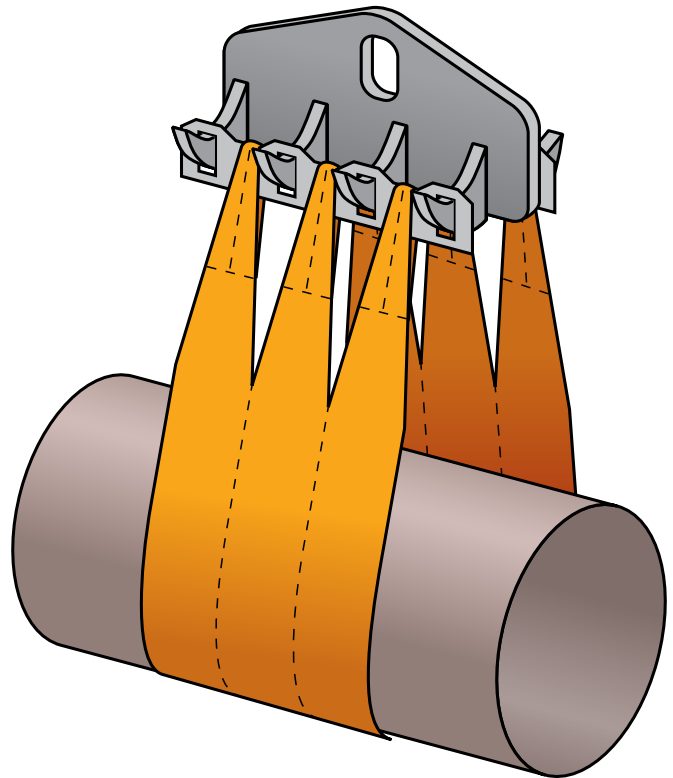
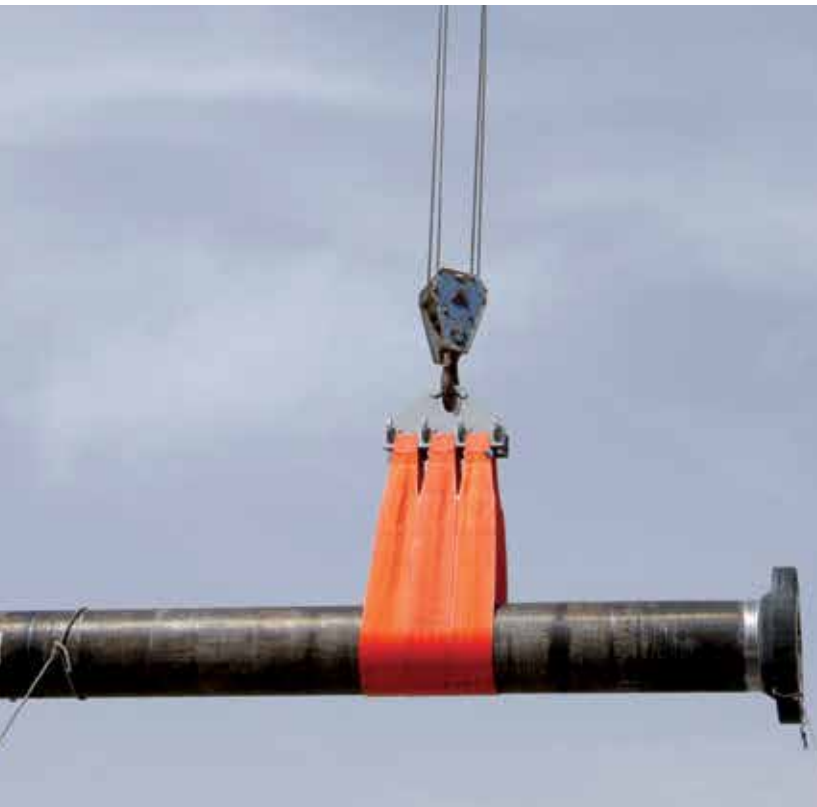

SPECIAL SLINGS

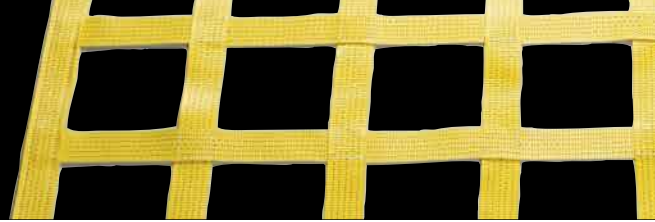

Single use Sling

One way sling or single use sling can be produced according to the customer's requirement. They can be manufactured with a safety factor of 5:1 or 7:1



Cargo Net

Cargo nets made of webbing or of rope material can be manufactured to different size and specification. Maximum size of the webbing net is limited to 3m X 3m. Rope nets could be made to bigger sizes.

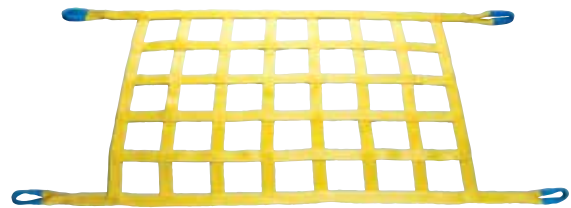

Drum lifting sling

Drum lifting sling DLS500 is used to lift and transport drums using a crane. The SWL of this sling is 500lbs and is easy to operate



Reefer Lifting sling

This sling is used to lift and transport refrigerated boxes or reefers and can be manufactured according to the need of the customer.



Boat lifting slings

Heavy duty slings for lifting boats can be manufactured according to customers requirement and specification. Protective sleeve made of polyester or rubber can be provided with these slings.



CARGO LASHINGS

CARGO LASHING

ALLSAFE manufactures a wide range of cargo lashings from 1" to 4" width and lashing capacities ranging from 400kg to 5000kg.

A two part system consists of a short part and a long part with a tensioning device provided on the short part. Variety of hooks can be provided.

Cargo lashings are manufactured according to European Norm EN12195-2.

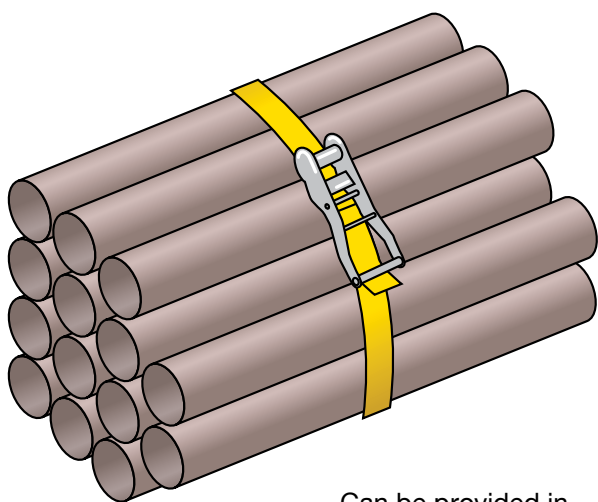
Single Part System
(Without hooks)

Can be provided in widths of 1", 1.5", 2", 3" and 4" to any length.

Safety Tips for Cargo Lashings

- Take into consideration the mode of use and the nature of the load to be secured.
- The size, shape and weight of the load, together with the intended method of use, transport environment and the nature of the load will affect the correct selection.
- For stability reasons free-standing units of load have to be secured with a minimum of one pair of web lashing for frictional lashing and two pairs of web lashing for diagonal lashing.
- Do not use different lashing equipment (e.g. lashing chain and web lashings) to lash the same load.
- Plan lifting and removal operations before starting the journey.
- Keep in mind that the load may have shifted during the journey.
- Do not use cargo lashing systems for lifting purposes.



CARGO LASHINGS TYPE

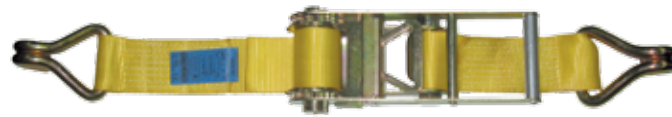

WIDTH 1", 25 mm
WEIGHT 0.6kg
BREAKING STRENGTH 1000kg
LASHING CAPACITY 400kg
COLOUR, YELLOW

CL01JR



DOUBLE J HOOK RATCHET



WIDTH 3", 75 mm
WEIGHT 7.2kg
BREAKING STRENGTH 10000kg
LASHING CAPACITY 3750kg
COLOUR, YELLOW

CL03JR



DOUBLE J HOOK RATCHET



WIDTH 1.5", 35 mm
WEIGHT 1.8kg
BREAKING STRENGTH 3000kg
LASHING CAPACITY 1200kg
COLOUR, YELLOW, GREY

CL35JR



DOUBLE J HOOK RATCHET



WIDTH 4", 75 mm
WEIGHT 7.5kg
BREAKING STRENGTH 6000kg
LASHING CAPACITY 3000kg
COLOUR, GREY

CL04FW



FLAT HOOK WINCH



WIDTH 2", 50 mm
WEIGHT 2.5kg
BREAKING STRENGTH 5000kg
LASHING CAPACITY 1825kg
COLOUR, YELLOW, BLUE, ORANGE



RATCHET



WIDTH 4", 75 mm
WEIGHT 9kg
BREAKING STRENGTH 10000kg
LASHING CAPACITY 5000kg
COLOUR, GREY

CL04JR



DOUBLE J HOOK RATCHET



	CL02JR DOUBLE J HOOK		CL02TR TRIANGLE HOOK
	CL02CR CLAW HOOK		CL02SR SNAP HOOK

All systems can be provided in any length.

Standard length: 10m

INSPECTION CRITERIA FOR WEBBING SLINGS

Proper and timely inspection of slings plays an important role in ensuring safety during any rigging and lifting operation.

- Before the first use of the sling, ensure that the manufacturer's certificate is at hand and the identification and SWL marked on the sling correspond with the information given on the label.
- Ensure that the type of the sling is suitable for the intended lift.
- Before each use, the sling should be inspected for defects and the identification and specification are correct.
- During the period of use, it is vital that periodic inspection of the slings should be carried out:
 - for defects or damages, including damages due to soiling.
 - by a competent authority and inspection details to be recorded.
 - at frequent intervals, based on the sling use and service condition.

Examples of defects or damages likely to affect the fitness of slings for continued safe use:

- Surface abrasion or chafe – In normal use some abrasion will occur to the surface fibres. This is normal and has little effect. Any substantial abrasion, particularly localized, is of concern and should be looked into carefully.
- Cuts – Cross or longitudinal cuts on the surface, near the eye, at the sides or on the stitches.
- Chemical attack – This results in local weakening and softening of the material.
- Heat or friction damage – This is indicated by fibres taking a glazed appearance and in some cases fusion of the fibres.
- Deformed or damaged fittings attached to the sling.

RECOMMENDATIONS FOR USE, HOW TO ORDER



RECOMMENDATION FOR USE

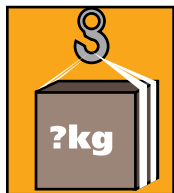

Check the weight of the load.
Do not overload slings.

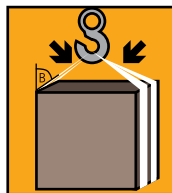

Take the slinging method and the lifting angle into accounts.

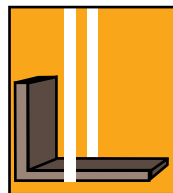

Remember to consider the centre of gravity of the load.

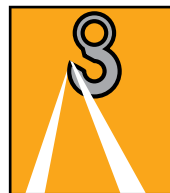

Never put slings on the point of hooks

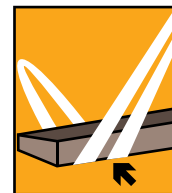

Protect slings from sharp edges

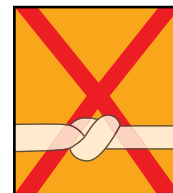

Never tie knots

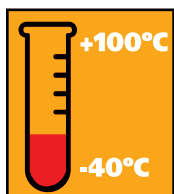

Use slings at temperature between -40°C and +100°C



In the event of exposure to chemicals, refer to the manufacturer



Take the dimension of the crane hook into account. If necessary use a reducing hook.

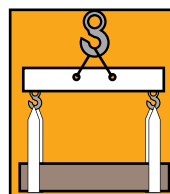

Support the load along the whole length of the lifting belts and slings

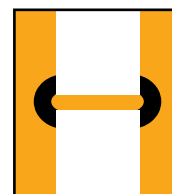

Connect belts and slings together using suitable metal rings or loops only

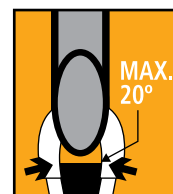

Maximum loop opening angle: 20°



Type of chemical

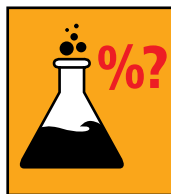

Concentration

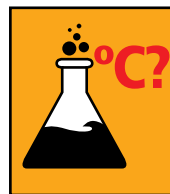

Temperature



Duration

INSTRUCTIONS FOR USE

- Comply with the temperature conditions when using round or flat belts slings. When there are sharp edges and/or abrasive surfaces, polyester protective covers or sleeves must be used.
- Storage: In a slightly heated room, away from, moisture and sunlights. Do not dry near a fire or other heat source.

**YOUR SAFETY DEPENDS ON THE CORRECT USE OF THESE PRODUCTS.
DO NOT HESITATE TO CONTACT US**

RECOMMENDATIONS FOR USE, HOW TO ORDER

Slings have to be used with care to avoid accidents and injuries.

- The operator will have to determine the weight of the load. The weight shall be within the rated capacity of the sling.
- The operator will have to select a sling having suitable characteristics for the type of load and environment.
- Slings should not be loaded in excess of the rated capacity.
- Slings with fittings which are used in a chocker lift shall be of sufficient length to assure that the chocking action is on the webbing and never on a fitting.
- Slings must always be protected from being cut by sharp corners, sharp edges, protrusions, or abrasive surfaces with protection sufficient for the intended purposes.
- Slings shall not be dragged on the floor or over abrasive surface.
- Slings shall not be twisted or tied into knots, shortened or joined by knotting.
- Slings shall not be pulled from under loads if the load is resting on the sling.
- Slings appear to be damaged shall not be used unless inspected and accepted (Contact us to inspect your slings).
- People shall stand clear of the suspended load. During lifting, people should be alert for possible snagging.
- Blocks have to be place under the load prior to setting down the same, to allow removal of the webbing sling.
- Polyester slings shall not be used in contact with objects or at temperatures above 90 degrees C.
- Exposure to sunlight or ultra violet light degrades the strength of the slings. Slings must be store in a cool dry and dark place when they are not in use.
- Make sure slings have legible identification tags before each use.



OUR CERTIFICATIONS

OUR CERTIFICATIONS

ALLSAFE is an ISO 9001:2008 certified company. All our CE products are certified to European Norms. In more than 15 years time, we maintained our quality level and good customer satisfaction to serve you the best at all times.

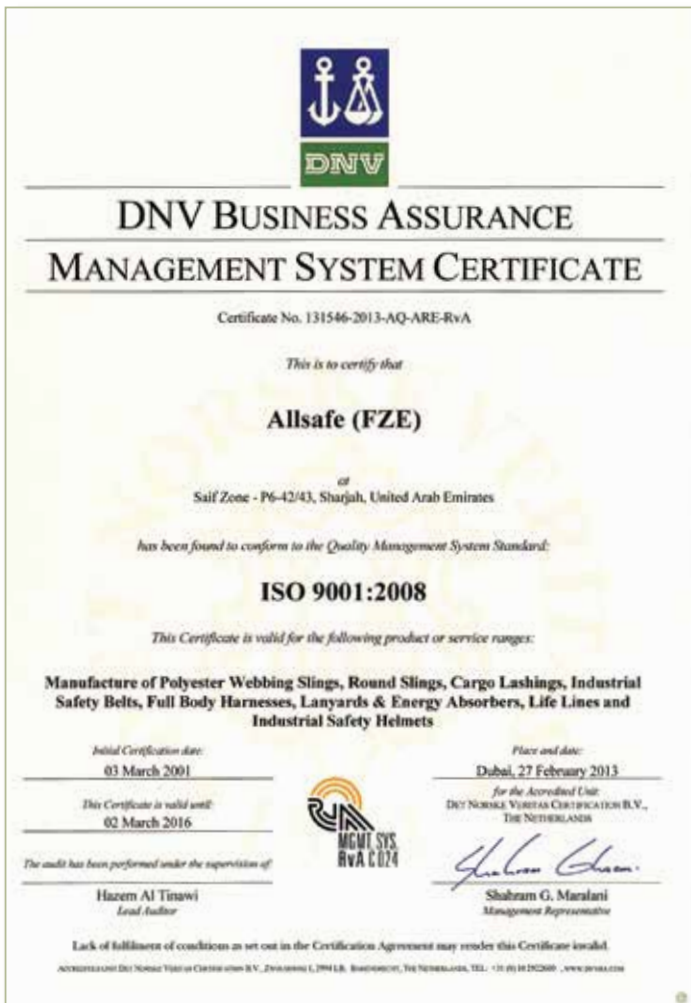

OUR IDENTIFICATION

PRODUCT LIABILITY AND TRACEABILITY

All our products are manufactured under controlled conditions using innovative Enterprise Resource planning system ensuring proper maintenance of records and traceability of products and components to its origin source. Each product is identified by suitable means and has a unique identification number. All products are covered under a product liability insurance enhancing the usage of the products and boosting the confidence of the customers.

Below you will see how to read our label and understand the meaning of the markings.

If you wish to make sure that our products are authentic, you can send us an email and we will be happy to assist you.

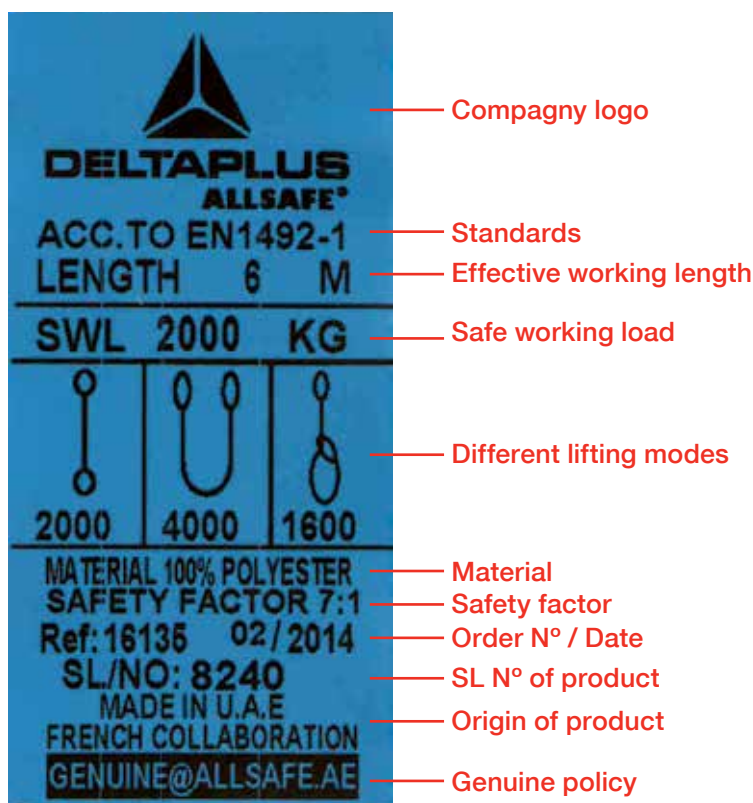

PACKAGING

- Each sling and cargo lashings are packed in an individual transparent plastic film.
- All products are provided with certificate of conformity

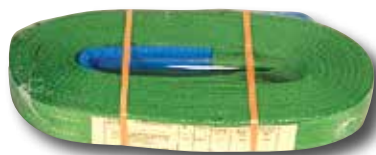

DELIVERY SERVICE

For the entire satisfaction of its customers, ALLSAFE always makes sure that each and every order is important and treated with high priority.

For our local orders placed before 12 midday we commit the delivery the next day, and for the export orders you get your delivery within 72 hours (depending on order quantity).

We want to make sure that you meet your deadlines and satisfy your customers at all times.



GENUINE POLICY

If you wish to make sure that your product is genuine, do not hesitate to send us an email with the batch number, we will be happy to assist you.

GENUINE@ALLSAFE.AE

FALL ARREST PROTECTION

To discover our full range of fall arrest equipment contact us or log on to:

